

RS/E-EV MZ SERIES

The RS/E-EV MZ burners series covers a firing range from 44 to 2650 kW, and it is based on a new Digital Burner Management System, Riello REC27, which is able to manage the air-fuel ratio by independent servomotors in order to obtain a perfect output control and to assure a correct combustion and safe operation on all modulation range. Operation can be "two stage progressive" or, alternatively, "modulating" with the installation of a PID logic regulator and respective probes. RS/E MZ burners series guarantees high efficiency levels in all the various applications, thus reducing fuel consumption and running costs.

The RS 250/EV MZ model, equipped with REC37, is available to operate with **Variable Speed Drive technology** base on the control of a Frequency Inverter that modifies the air flow through the motor speed variation.

Optimisation of sound emissions is guaranteed by the special design of the air suction circuit and by incorporated sound proofing material.



RS 34/E MZ	44/130 ÷	390 kW
RS 44/E MZ	80/200 ÷	550 kW
RS 50/E MZ	85/290 ÷	580 kW
RS 64/E MZ	150/400 ÷	850 kW
RS 70/E	135/465 ÷	814 kW
RS 100/E	150/698 ÷	1163 kW
RS 130/E	254/920 ÷	1600 kW
RS 190/E	470/1279 ÷	2290 kW
RS 250/E MZ	600/1250 ÷	2650 kW
RS 250/EV MZ	600/1250 ÷	2650 kW

FIRING RATES

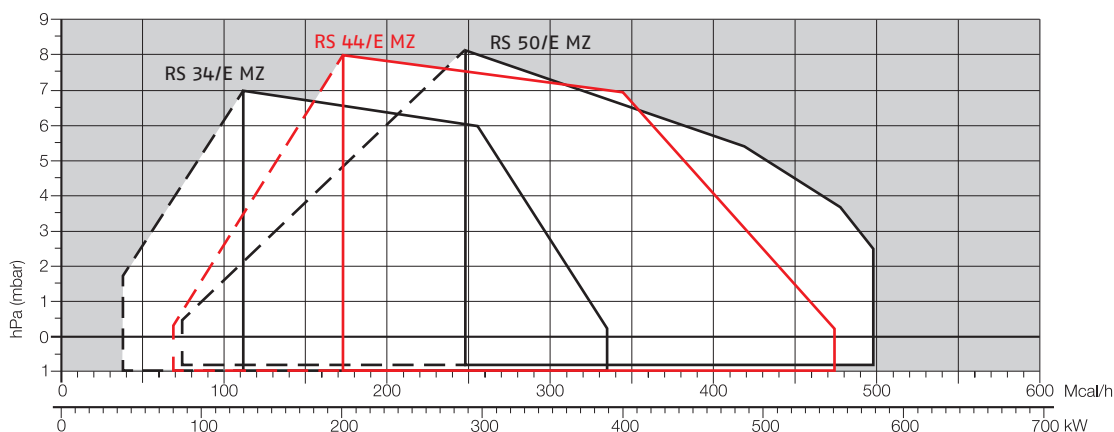

 Useful working field for choosing the burner

 Modulation range

Test conditions conforming to EN676
 Temperature: 20°C
 Pressure: 1013,5 mbar
 Altitude: 0 m a.s.l.

Modulating Gas Burners

RS/E-EV MZ SERIES

FIRING RATES

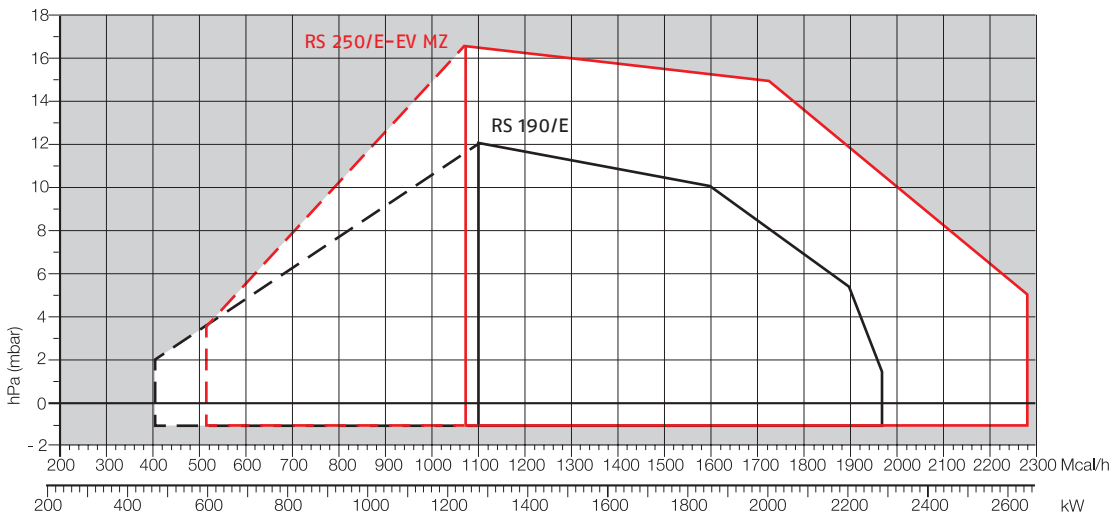
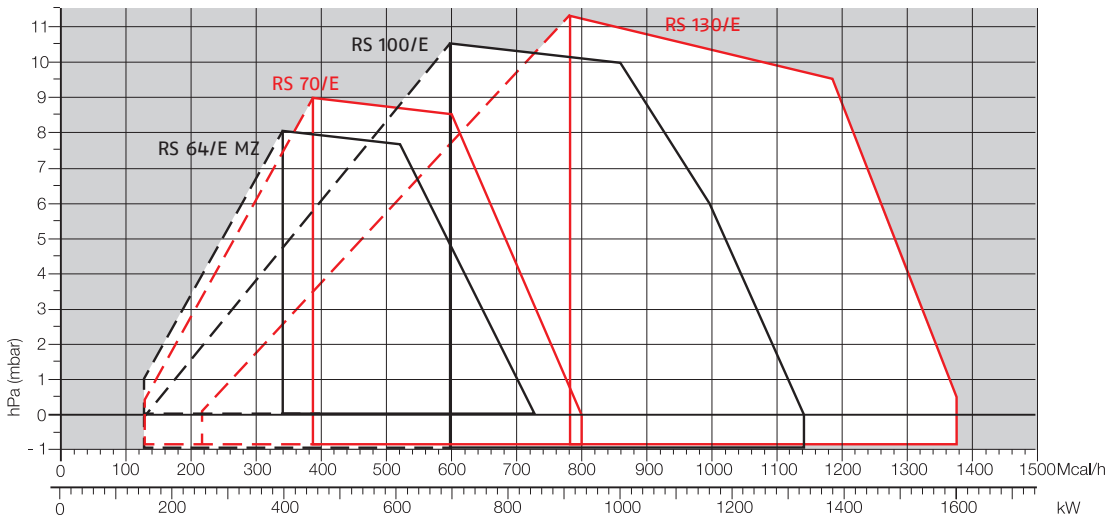

Overall dimensions (mm)

BURNER

RS 34-44/E MZ

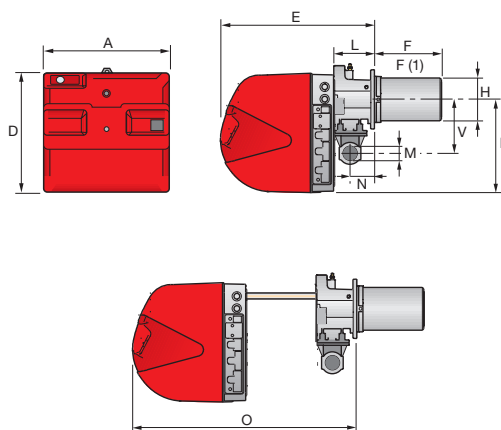

RS 50/E MZ

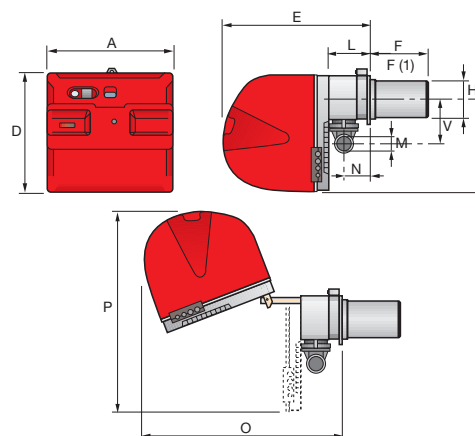

MODEL	A	D	E	F - F(1)	H	I	L	M	N	O	P	V
▶ RS 34/E MZ	442	422	508	216 - 351	140	305	138	1 1/2	84	780	-	177
▶ RS 44/E MZ	442	422	508	216 - 351	152	305	138	1 1/2	84	780	-	177
▶ RS 50/E MZ	476	474	580	216 - 351	152	352	164	1 1/2	108	810	719	168

(1) dimension with extended head

RS 64/E MZ

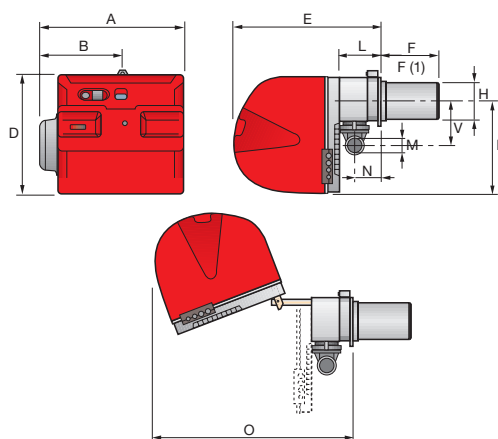

RS 70-100-130-190/E - RS 250/E-EV MZ

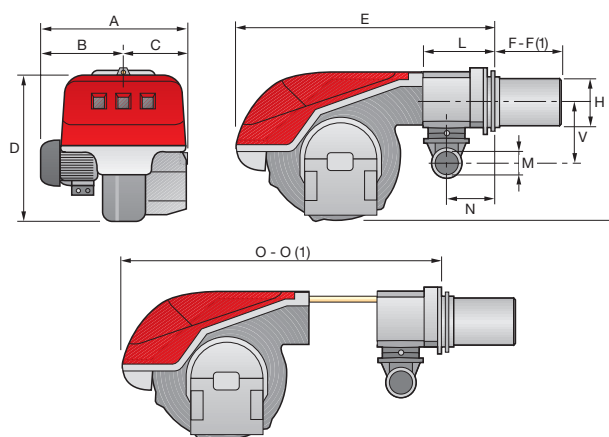

MODEL	A	B	C	D	E	F - F(1)	H	I	L	M	N	O - O(1)	V
▶ RS 64/E MZ	533	300	-	490	640	250 - 385	179	352	222	2"	134	810 - -	221
▶ RS 70/E	527	312	215	555	840	250 - 385	179	430	214	2"	134	1161 - 1296	221
▶ RS 100/E	527	312	215	555	840	250 - 385	179	430	214	2"	134	1161 - 1296	221
▶ RS 130/E	553	338	215	555	840	280 - 415	189	430	214	2"	134	1161 - 1296	221
▶ RS 190/E	675	370	305	555	856	372 - 530	222	436	230	2"	150	1328 - -	264
▶ RS 250/E-EV MZ	732	427	305	555	872	370 - 520	222	436	230	2"	150	1322 - 1467	264

(1) dimension with extended head

Modulating Gas Burners

RS/E-EV MZ SERIES

Overall dimensions (mm)

BURNER - BOILER MOUNTING FLANGE

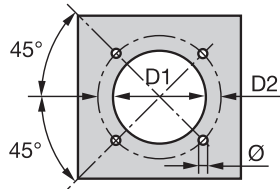

MODEL	D1	D2	Ø
▶ RS 34/E MZ	160	224	M8
▶ RS 44/E MZ	160	224	M8
▶ RS 50/E MZ	160	224	M8
▶ RS 64/E MZ	185	275-325	M12
▶ RS 70/E	185	275-325	M12
▶ RS 100/E	185	275-325	M12
▶ RS 130/E	195	275-325	M12
▶ RS 190/E	230	325-368	M16
▶ RS 250/E-EV MZ	230	325-368	M16

PACKAGING

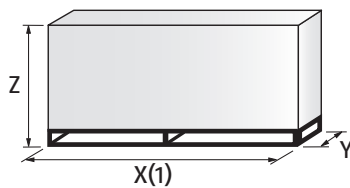

MODEL	X (1)	Y	Z	kg
▶ RS 34/E MZ	1000	485	500	39
▶ RS 44/E MZ	1000	485	500	40
▶ RS 50/E MZ	1200	502	630	48
▶ RS 64/E MZ	1200	580	630	50
▶ RS 70/E	1405	700	660	78
▶ RS 100/E	1405	700	660	81
▶ RS 130/E	1405	700	660	84
▶ RS 190/E	1405	1000	660	89
▶ RS 250/E-EV MZ	1405-1420	1000	660	125

(1) dimension with standard and extended head

Specification

DESIGNATION OF SERIES

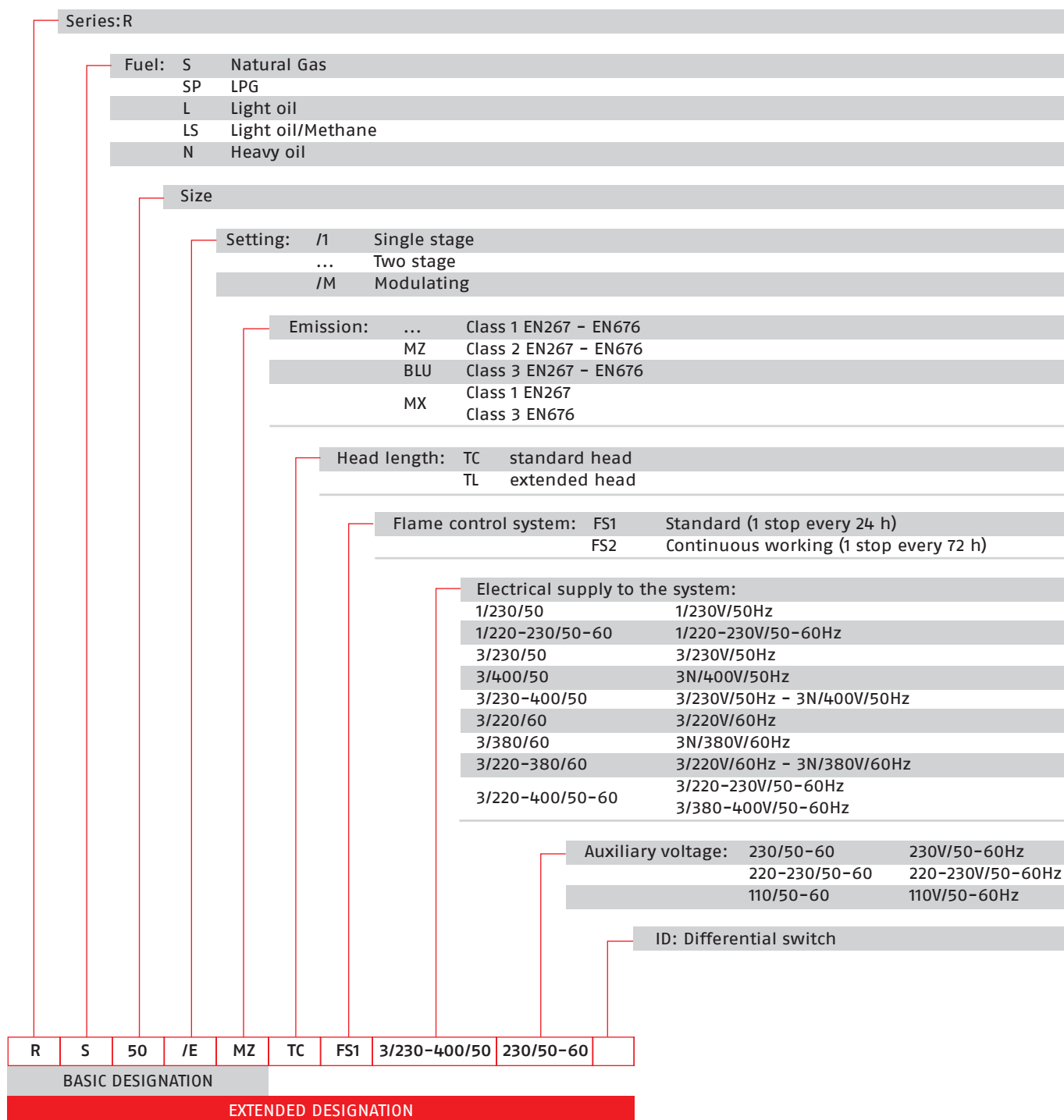

Specification

STATE OF SUPPLY

RS 34/E MZ – 44/E MZ models

Monoblock forced draught Low NOx gas burner with two stage progressive or modulating operation, with a specific kit, fully automatic, made up of:

- Microprocessor-based Digital Burner Management System (Electronic Cam)
- Display Interface operating unit to adjust the system
- Air suction circuit **with sound proofing material**
- High performance fan with straight blades
- Air damper for air flow setting and butterfly valve for regulating fuel output controlled by independent stepper motor actuators
- Starting motor at 2800 rpm, single-phase/220-230V/50-60Hz or three-phase/380-400V/50-60Hz
- Low emission combustion head, that can be set on the basis of required output, fitted with:
 - stainless steel end cone, resistant to corrosion and high temperatures
 - ignition electrodes
 - ionisation probe
 - gas distributor
 - flame stability disk
- Exclusive patented HCS (Housing Cooling System) with high thermal insulation and air circulation with continuous air volume refresh for an active cooling system and avoid heat transfer to the electrical component housing
- Minimum air pressure switch stops the burner in case of insufficient air quantity at the combustion head
- Plugs and sockets for electrical connection, accessible from the external of the cover
- Burner on/off selection switch
- Flame inspection window
- Slide bars for easier installation and maintenance
- Protection filter against radio interference
- IP X0D (IP 40) electric protection level.

Standard equipment:

- 1 gas train flange
- 1 flange gasket
- 4 screws for fixing the flange
- 1 thermal screen
- 4 screws for fixing the burner flange to the boiler
- 3 plugs for electrical connection (RS 34-44/E MZ single-phase)
- 4 plugs for electrical connection (RS 44/E MZ three-phase)
- Instruction handbook for installation, use and maintenance
- Spare parts catalogue.

RS/E-EV MZ SERIES

Specification

STATE OF SUPPLY

RS 50/E MZ - 64/E MZ - 70/E - 100/E - 130/E - 190/E - 250/E-EV MZ models

Monoblock forced draught Low NO_x gas burner with two stage progressive or modulating operation, with a specific kit, fully automatic, made up of:

- Microprocessor-based Digital Burner Management System (Electronic Cam)
- Display Interface operating unit to adjust the system
- Air suction circuit lined with sound-proofing material
- Fan with reverse curve blades (straight blades on the RS 64/E MZ - 190/E - 250/E-EV MZ models) high performance with low sound emissions
- Air damper for air flow setting and butterfly valve for regulating fuel output controlled by independent stepper motor actuators
- Starting motor at 2800 rpm, three-phase 400V with neutral, 50Hz
- Low emission combustion head, that can be set on the basis of required output, fitted with:
 - stainless steel end cone, resistant to corrosion and high temperatures
 - ignition electrodes
 - ionisation probe
 - gas distributor
 - flame stability disk
- Maximum gas pressure switch to stop the burner in the case of excess pressure on the fuel supply line
- Minimum air pressure switch stops the burner in case of insufficient air quantity at the combustion head
- Burner on/off selection switch
- Flame inspection window
- Slide bars for easier installation and maintenance
- Protection filter against radio interference
- IP 44 electric protection level.

Standard equipment:

- 1 gas train flange
- 1 flange gasket
- 4 screws for fixing the flange
- 1 thermal screen
- 4 screws for fixing the burner flange to the boiler
- Wiring loom fittings for the electrical connection
- 2 slide bar extensions (for extended head models and RS 190/E - 250/E-EV MZ models)
- Pressure switch for valve proofing system (RS 130/E - 190/E - 250/E-EV MZ models)
- Instruction handbook for installation, use and maintenance
- Spare parts catalogue.

Modulating Gas Burners

RS/E-EV MZ SERIES

Available models

Burners

CODE	MODEL					HEAT OUTPUT NATURAL GAS		TOTAL ELECTRICAL POWER (kW)	CERTIFICATION	NOTE
						(kW)	(Nm ³ /h)			
3789410	RS 34/E MZ	TC	FS1	1/220-230/50-60	220-230/50-60	44/130÷390	4,5/13÷39	0,6	CE 0085BS0378	(1)(3)
3789411	RS 34/E MZ	TL	FS1	1/220-230/50-60	220-230/50-60	44/130÷390	4,5/13÷39	0,6	CE 0085BS0378	(1)(3)
3789510	RS 44/E MZ	TC	FS1	1/220-230/50-60	220-230/50-60	80/200÷550	8/20÷55	0,7	CE 0085BS0378	(1)(3)
3789511	RS 44/E MZ	TL	FS1	1/220-230/50-60	220-230/50-60	80/200÷550	8/20÷55	0,7	CE 0085BS0378	(1)(3)
3789540	RS 44/E MZ	TC	FS1	3/220-400/50-60	220-230/50-60	80/200÷550	8/20÷55	0,75	CE 0085BS0378	(1)(3)
3789541	RS 44/E MZ	TL	FS1	3/220-400/50-60	220-230/50-60	80/200÷550	8/20÷55	0,75	CE 0085BS0378	(1)(3)
3781632	RS 50/E MZ	TC	FS1	3/230-400/50	230/50-60	85/290-580	8,5/29-58	0,75	CE 0085AQ0709	(1)(3)
3781633	RS 50/E MZ	TL	FS1	3/230-400/50	230/50-60	85/290-580	8,5/29-58	0,75	CE 0085AQ0709	(1)(3)
3789910	RS 64/E MZ	TC	FS1	3/230-400/50	230/50-60	150/400÷850	15/40÷85	1,2	in progress	(1)(3)
3789911	RS 64/E MZ	TL	FS1	3/230-400/50	230/50-60	150/400÷850	15/40÷85	1,2	in progress	(1)(3)
3787032	RS 70/E	TC	FS1	3/230-400/50	230/50-60	135/465-814	13,5/46,5-81	1,6	CE 0085AQ0708	(2)(3)
3787033	RS 70/E	TL	FS1	3/230-400/50	230/50-60	135/465-814	13,5/46,5-81	1,6	CE 0085AQ0708	(2)(3)
3787232	RS 100/E	TC	FS1	3/230-400/50	230/50-60	150/698-1163	15/70-116	2,0	CE 0085AQ0708	(2)(3)
3787233	RS 100/E	TL	FS1	3/230-400/50	230/50-60	150/698-1163	15/70-116	2,0	CE 0085AQ0708	(2)(3)
3787432	RS 130/E	TC	FS1	3/230-400/50	230/50-60	160/930-1512	16/93-151	2,8	CE 0085AQ0708	(2)(4)
3787433	RS 130/E	TL	FS1	3/230-400/50	230/50-60	160/930-1512	16/93-151	2,8	CE 0085AQ0708	(2)(4)
3787632	RS 190/E	TC	FS1	3/400/50	230/50-60	470/1279-2290	47/128-229	5,3	in progress	(2)(4)
20052617	RS 190/E	TL	FS1	3/400/50	230/50-60	470/1279-2290	47/128-229	5,3	in progress	(2)(4)
on demand	RS 190/E	TC	FS1	3/230/50	230/50-60	470/1279-2290	47/128-229	5,3	in progress	(2)(4)
3789210	RS 250/E MZ	TC	FS1	3/400/50	230/50-60	600/1250÷2650	60/125÷265	6,5	CE 0085BT0061	(2)(4)
3789211	RS 250/E MZ	TL	FS1	3/400/50	230/50-60	600/1250÷2650	60/125÷265	6,5	CE 0085BT0061	(2)(4)
3789240	RS 250/E MZ	TC	FS1	3/230/50	230/50-60	600/1250÷2650	60/125÷265	6,5	CE 0085BT0061	(2)(4)
3789241	RS 250/E MZ	TL	FS1	3/230/50	230/50-60	600/1250÷2650	60/125÷265	6,5	CE 0085BT0061	(2)(4)
20010541	RS 250/E MZ	TC	FS1	3/380/60	220/60	600/1250÷2650	60/125÷265	6,5	--	(2)(4)
20014098	RS 250/EV MZ	TC	FS1	3/400/50	230/50-60	600/1250÷2650	60/125÷265	6,5	CE 0085BT0061	(2)(4)
20014515	RS 250/EV MZ	TL	FS1	3/400/50	230/50-60	600/1250÷2650	60/125÷265	6,5	CE 0085BT0061	(2)(4)

Natural Gas, net calorific value: 10 kWh/Nm³ - Density at 20°C: 0,71 kg/Nm³

The burners of RS/E MZ series are in according to 2009/142 - 2004/108 - 2006/95 - 2006/42 EC Directive and EN 676 Norm.

(1) With plug and socket.

(2) With terminal board.

(3) Seal control function is included on Burner Digital Management System; it is necessary to add the PVP kit on the gas train as Accessory (see Gas Train Accessories paragraph).

(4) Seal control function is included on Burner Digital Management System; it is necessary to add the PVP kit (included as burner standard equipment) on the gas train.

Available models

Gas Trains

CODE	GAS TRAIN		ADAPTER CODE								
	MODEL	Ø	RS 34	RS 44-50	RS 64	RS 70	RS 100	RS 130	RS 150	RS 190	RS 250
3970599*	MB 407/1 - RT 52	Rp ¾"	3000824		●	●	●	●	●	●	●
3970258*	MB 410/1 - RT 52	Rp 1" ¼	3010124		3000843		●	●	●	●	●
3970600*	MB 410/1 - RT 52	Rp ¾"	3000824		3000824 + 3000843		●	●	●	●	●
3970256*	MB 412/1 - RT 52	Rp 1" ½	-	-	3000843						
3970250*	MB 415/1 - RT 52	Rp 1" ½	-	-	3000843						
3970257*	MB 420/1 - RT 52	Rp 2"	3000822		-	-	-	-	-	-	-
3970221*	MBC 1200/1 - RSM 60	Rp 2"	3000822		-	-	-	-	-	-	-
3970222*	MBC 1900/1 - FSM 40	DN 65	●	●	3000825						
3970223*	MBC 3100/1 - FSM 40	DN 80	●	●	3000826						
3970224	MBC 5000/1 - FSM 80	DN 100	●	●	●	●	●	●	●	●	3010370 + 3000826
3970145*	CB 512/1 - RSM 30	Rp 1" ½	-	-	3000843						
3970146*	CB 520/1 - RSM 30	Rp 2"	3000822		-	-	-	-	-	-	-
20044659*	CB 525/1 - RSM 30	Rp 2"	3000822		-	-	-	-	-	-	-
3970147*	CB 5065/1 - FSM 30	DN 65	●		3000825						
3970148*	CB 5080/1 - FSM 30	DN 80	●	●	3000826						
3970149*	CB 50100/1 - FSM 30	DN 100	●	●	3010370 + 3000826						
20015871*	CB 50125/1 - FSM 30	DN 125	●	●	●	●	●	3010224 + 3000826			

Please see designation of Gas Train Series in the page before the Catalogue index.

* gas train are 230V/50Hz - 220V/60Hz electrical supply.

The valve seal control device is compulsory (conforming to EN 676) on gas trains to burners with a maximum output over 1200 kW.

The seal control function is managed by REC control box, by installation on gas train of a pressure switch (please see Gas train accessories paragraph); it is included as standard equipment on RS 130/E-190/E-250/E-EV MZ models.

The seal control function is managed by LMV control box, by installation on gas train of pressure switch supplied, as standard equipment, with the burner.

To select the gas train please refer to the technical data leaflet and/or instruction manual.

● Not available.

Modulating Gas Burners

RS/E-EV MZ SERIES

Burner accessories

Extended heads

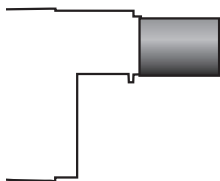

“Standard head” burners can be transformed into “extended head” versions, by using the special kit. The KITS available for the various burners, giving the original and the extended lengths, are listed below.

BURNER	'STANDARD HEAD' LENGTH (mm)	'EXTENDED HEAD' LENGTH (mm)	KIT CODE
▶ RS 34/E MZ	216	351	3010428
▶ RS 44/E MZ	216	351	3010429
▶ RS 50/E MZ	216	351	20008182
▶ RS 64/E MZ	250	385	3010427
▶ RS 70/E	250	385	3010117
▶ RS 100/E	250	385	3010118
▶ RS 130/E	280	415	3010119
▶ RS 190/E	372	530	3010443
▶ RS 250/E-EV MZ	370	520	3010412

Spacer kit

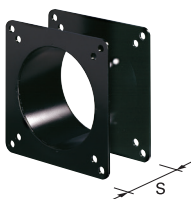

If burner head penetration into the combustion chamber needs reducing, varying thickness spacers are available, as given in the following table:

BURNER	SPACER THICKNESS S (mm)	KIT CODE
▶ RS 34-44-50/E MZ	110	3010095
▶ RS 64/E MZ - RS 70-100-130/E	135	3010129
▶ RS 190/E - RS 250/E-EV MZ	102	3000722

Continuous ventilation kit



If the burner requires continuous ventilation in the stages without flame, a special kit is available as given in the following table:

BURNER	KIT CODE
▶ RS 34-44/E MZ	3010449
▶ RS 50-64/E MZ - RS 70-100-130-190/E - RS 250/E-EV MZ	3010094

Sound proofing box

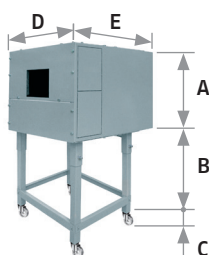

If noise emission needs reducing even further, sound-proofing boxes are available. In case of generator heights, where a lower dimension “B” is required, ask for the Box Support Kit code 20065135. The useful dimensions are 40 mm less than the total dimensions indicated in the table (A, D, E). Not suitable for outdoor use.

BURNER	BOX TYPE	A (mm)	B (mm) min-max	C (mm)	D (mm)	E (mm)	[dB(A)] (*)	BOX CODE
▶ RS 34-44-50-64/E MZ	C1/3	650	372 - 980	110	690	770	10	3010403
▶ RS 70-100-130-190/E ▶ RS 250/E-EV MZ	C4/5	850	160 - 980	110	980	930	10	3010404

(*) Average noise reduction according to EN 15036-1 standard

Burner accessories

Accessories for modulating operation



To obtain modulating operation, the RS/E series of burners requires a regulator with three point outlet controls. On RS 34/E MZ - 44/E MZ - 250/E MZ the regulator is connected to the burner electrical wiring by plug-in system in order to make the connection easier and faster.

The relative temperature or pressure probes fitted to the regulator must be chosen on the basis of the application.

The following table lists the accessories for modulating operation with their application range.

BURNER	REGULATOR TYPE	CODE
▶ RS 34-44-64/E MZ	RWF 40	3010417
▶ RS 50/E MZ - RS 70-100-130-190/E - RS 250/E-EV MZ	RWF 40	3010414



BURNER	PROBE TYPE	RANGE (°C) (bar)	CODE
▶ All models	Temperature PT 100	-100 ÷ 500°C	3010110
	Pressure 4 ÷ 20 mA	0 ÷ 2,5 bar	3010213
	Pressure 4 ÷ 20 mA	0 ÷ 16 bar	3010214
	Pressure 4 ÷ 20 mA	0 ÷ 25 bar	3090873

Connection flange kit

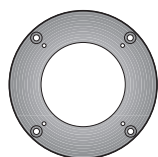

A kit is available for use where the burner opening on the boiler is of excessive diameter.

BURNER	KIT CODE
▶ RS 34-44-50/E MZ	3010138

LPG kit



For burning LPG gas, a special kit is available to be fitted to the combustion head on the burner, as given in the following table:

BURNER	KIT CODE FOR 'STANDARD HEAD'	KIT CODE FOR 'EXTENDED HEAD'
▶ RS 34/E MZ	3010423	3010423
▶ RS 44/E MZ	3010424	3010424
▶ RS 50/E MZ	20008173	20008173
▶ RS 64/E MZ	3010434	3010435
▶ RS 70/E	20008175	20008176
▶ RS 100/E	20008177	20008178
▶ RS 130/E	20008179	20008180
▶ RS 190/E	3010166	3010166
▶ RS 250/E-EV MZ	3010411	3010411

Modulating Gas Burners

RS/E-EV MZ SERIES

Burner accessories

Town gas kit

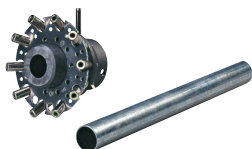

For burning Town gas, a special kit is available:

BURNER	KIT CODE FOR 'STANDARD HEAD' (*)	KIT CODE FOR 'EXTENDED HEAD' (*)
▶ RS 34/E MZ	3010502	3010502
▶ RS 44/E MZ	3010503	3010503
▶ RS 50/E MZ	3010285	3010285
▶ RS 70/E	3010286	3010286
▶ RS 100/E	3010287	3010287
▶ RS 130/E	3010288	3010288
▶ RS 190/E	3010297	3010297

(*) Without CE certification

Ground fault interrupter kit



A "Ground fault interrupter kit" is available as a safety device for electrical system fault.

BURNER	KIT CODE
▶ RS 34-44/E MZ	3010448
▶ RS 50-64/E MZ	20098335
▶ RS 70-100-130-190/E - RS 250/E-EV MZ	20098337

Gas max pressure switch

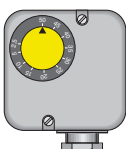

If necessary a Gas max pressure Switch kit is available and connectable to the burner electrical wiring through Plugs & Sockets system.

BURNER	KIT CODE
▶ RS 34-44/E MZ	3010418

Volt free contact kit



A volt free contact kit is available for installation onto the burner. It can be used for a remote interface between burner operating signals. Every burner can be equipped with a single kit for a remote check of the flame presence signal and the burner lock-out indication.

BURNER	KIT CODE
▶ RS 34-44/E MZ	3010419

DN80 gas flange kit

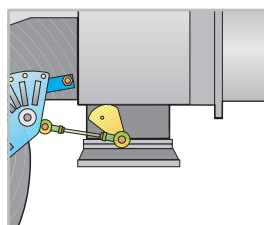

To modify the standard 2" burner gas input connection in to DN80 connection, a specific gas flange is available.

BURNER	KIT CODE
▶ RS 64/E MZ - RS 70-100-130-190/E - RS 250/E EV MZ	3010439

Burner accessories

Variable Speed Drive (VSD) for RS/EV series only



The motor speed variation for the RS/EV MZ burners series is obtained thanks to a frequency converter: variable speed drive (VSD), provided with a programming panel with start-up assistant. It always must be ordered with RS/EV series.

BURNER	MAX POWER (kW)	KIT CODE
► RS 250/EV MZ	5,5	20062679

PC Interface kit



To connect the control box to a personal computer for the transmission of operation, fault signals and detailed service information, an interface adapter with PC software are available.

BURNER	KIT CODE
► RS 34-44-50-64/E MZ - RS 70-100-130-190/E - RS 250/E-EV MZ	3010436

OCI412 interface kit



Interface kit between the REC27.100A2 and a Modbus system, such as a building automation and control system (BACS). The Modbus interface is based on the RS-485 standard.

BURNER	KIT CODE
► RS 34-44-50-64/E MZ - RS 70-100-130-190/E - RS 250/E-EV MZ	3010437

Head kit for "reverse flame chamber"



In certain cases, the use of the burner on reverse flame boilers can be improved by using an additional cylinder.





BURNER	STANDARD HEAD LENGTH WITH CYLINDER (mm)	EXTENDED HEAD LENGTH WITH CYLINDER (mm)	KIT CODE (*)
► RS 190/E	493	-	3010241

(*) EC certification in progress

Gas train accessories

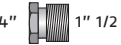
Adapters

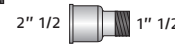
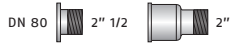
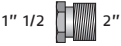
In certain cases, an adapter must be fitted between the gas train and the burner, when the diameter of the gas train is different from the set diameter of the burner. Below are given the available adapters; please see on the Gas Train list the correct adapter codes to select.

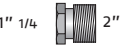
ADAPTER	LENGTH mm	ADAPTER CODE
 2" 1 1/2"	70	3000822
 3/4" 1 1/2"	31	3000824
 DN 65 2" 1/2 2"	300	3000825
 DN 65 2" 1/2 1 1/2"		
 DN 80 2" 1/2 2"	300	3000826
 1" 1/2 2"	35	3000843
 1" 1/4 1 1/2"	35	3010124
 1" 1/4 2"	35	3010126

Stabiliser spring



Accessory springs are available to vary the pressure range of the gas train stabilisers. The following table shows these accessories with their application range. Please refer to the technical manual for the correct choice of spring.

GAS TRAIN	SPRING COLOUR	SPRING PRESSURE RANGE mbar	SPRING CODE
▶ MBC 1900/1 - 3100/1 MBC 5000/1	White	4 - 20	3010381
	Red	20 - 40	3010382
	Black	40 - 80	3010383
	Green	80 - 150	3010384
▶ CB 512/1	Red	25 - 55	3010131
	Black	60 - 110	3010157
▶ CB 520/1 - 525/1	Pink	90 - 150	3090486
	Red	25 - 55	3010132
	Black	60 - 110	3010158
	Pink	100 - 150	3090487
▶ CB 5065/1 - 5080/1	Red	25 - 55	3010133
	Black	60 - 110	3010135
	Pink	100 - 150	3090456
	Grey	140 - 200	3090992

PVP (Pressure Valve Proving) kit *

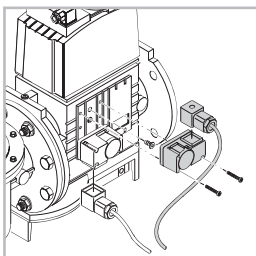

The seal control function is included on Burner Digital Management System, it is only necessary to add the PVP kit on the gas train. The PVP is included as standard equipment on RS 130/E-250/E-EV MZ and RS 190/E models.

BURNER	KIT CODE
▶ MB - MBC - CB type	3010344

* not necessary for the RS 130/E-250/E MZ and RS 190/E models where is included as a standard.